

Fun & Play Baby Walker

Instruction manual



IMPORTANT! READ CAREFULLY AND KEEP FOR FUTURE REFERENCE

This product is intended only for a child who can sit up by itself and until it is able to walk by itself or weighs more than 12 kg.

BS EN 1273:2020+A1:2023.

Safety Instructions



WARNING:

- Never leave the child unattended.
 - The child will be able to reach further and move rapidly when in the baby walking frame:
 - Prevent access to stairs, steps and uneven surfaces.
 - Guard all fires, heating and cooking appliances.
 - Remove hot liquids, electrical cables and other potential hazards from reach.
-
- This baby walking frame is intended for indoor use only.
 - As the child is able to move rapidly when in a baby walking frame, be aware that the child can reach hazardous areas in the house, like a bathtub, household kitchen / laundry appliances, heating devices, bookshelves / furniture from which an object can fall, etc.
 - Prevent collisions with glass in doors, windows and furniture.
 - This product is intended only for a child who can sit up by itself and until it is able to walk by itself or weighs more than 12 kg.
 - This baby walking frame should be used only for short periods of time (e.g. 20 min).
 - Do not use the product if any components are broken or missing.
 - Do not use accessories or replacement parts other than those approved by the manufacturer.
 - Never use the baby walking frame without the supplied anti-fall blocks attached.
 - Never use the baby walking frame without the supplied wheels attached.
 - To avoid damage to parts and potential safety concerns this product must not be disassembled, except for the seat unit and toy tray.

Care and Maintenance

- To prolong the life of your nursery product keep it clean and do not leave it in direct sunlight for extended periods of time.
- Removable fabric covers and trims may be cleaned using a damp sponge with a household soap or a mild detergent. Allow it to dry fully, preferably away from direct sunlight.
- If the wheels squeak - use a silicon based spray ensuring it penetrates the wheel and axle assembly.
- Do not dry clean, or use bleach.
- Do not machine wash, tumble or spin dry, unless the care labelling on the product permits these methods.
- In some climates the covers and trims may be affected by mould and mildew. To help prevent this occurring, do not fold or store the product if it is damp or wet. Always store the product in a well ventilated area.
- Always check parts regularly for tightness of screws, nuts and other fasteners - tighten if required. If any parts are bent, torn, worn or broken please contact Customer Service.

Welcome







Thank you for purchasing the Puggle 3 in 1 Fun & Play Baby Walker.
Please read the instructions and warnings carefully before use to ensure safe and satisfactory operation of this product.

Your child's safety is your responsibility. If you have a query with this product or require replacement parts, please contact us at online4baby.com/contact-us.

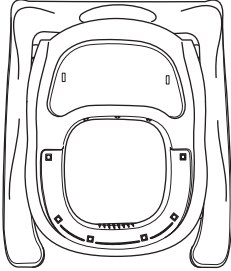
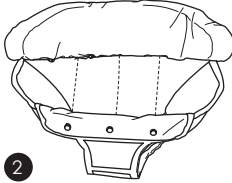
Lay out the parts on a soft level surface and compare to the part/fixings checklist. Do not discard any packaging until you are sure that you have all the parts.

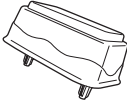
WARNING! Assembly by an adult. Keep away from children until fully assembled. Keep children clear during assembly as pack contains small parts which may present a choking hazard.

Parts Checklist

		Contained in your carton are:
Nº	Part	Qty
	Walker body	1
	Seat unit	1
	Front wheels	2
	Rear wheels	2
	Anti-fall blocks	6
	Toy bar	1
	Toy bar base	2
	Butterfly toy	1
	Flower toy	1

Opening and Closing the Baby Walker

WARNING! NEVER adjust the height when your child is in the walker. DO NOT place your child in until you have adjusted the height and made sure it is locked in place.

1. **To open:** hold either side of the upper part of the walker and pull upwards to one of the three height positions. Ensure the upper part of the walker clicks into position.

Note: There is a click for each of the three height positions. The walker is fully open when you hear the 3rd click.

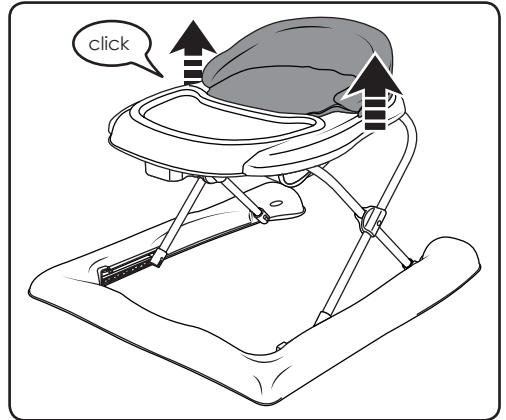

2. **To close:** Hold the front of the walker and at the same time, turn and pull the locking mechanism forward and lower the upper part of the walker all the way down.

3. **To adjust the height:** The simplest method to adjust the height is to lower the upper part of the walker all the way down (as above, in step 2) then pull the upper part of the walker back up so that it clicks into one of the three height positions.

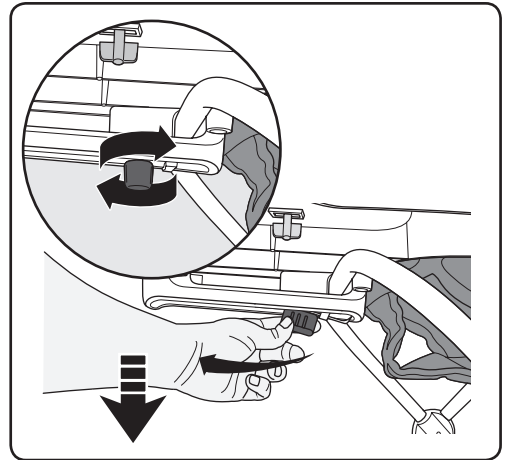

Attaching the walker's anti-fall blocks

1. Attaching the anti-fall blocks: With the baby walker upside down and fully folded down, place the anti-fall blocks around the walker as shown, inserting the two plastic stems on each block into the holes on the walker's underside.

WARNING! DO NOT USE THE WALKER WITHOUT THE ANTI-FALL BLOCKS ATTACHED.

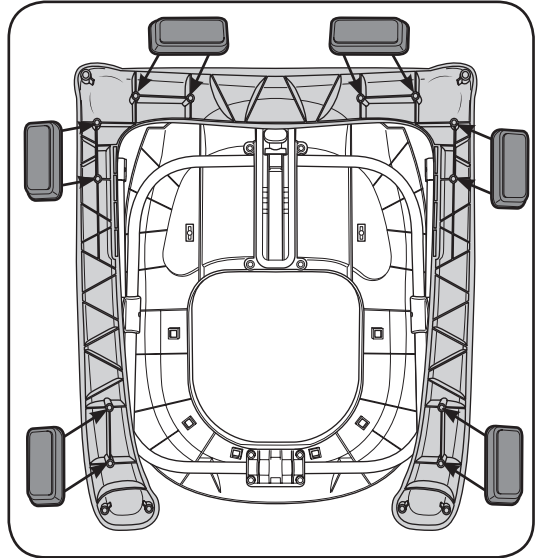

Attaching the walker's front and rear wheels

WARNING! Never use the walker without the wheels attached.

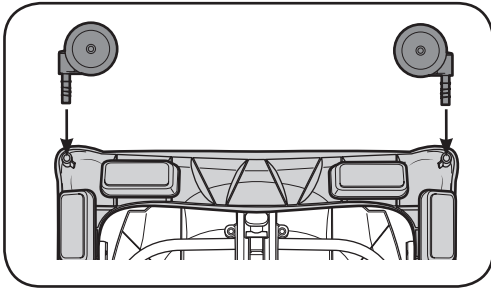

1. Attaching the front wheels: With the baby walker still upside down and fully folded down, insert both front wheels fully into each round hole on either corner at the front of the walker.

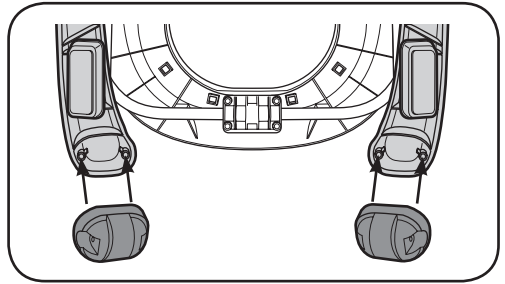

2. Attaching the rear wheels: With the baby walker still upside down and fully folded down, insert both rear wheels into the two round holes on either corner at the rear of the walker.

Fitting the Seat Unit

1. Lower the walker all the way down, place the walker on a flat level surface then place the seat unit in to the centre of the baby walker.

2. Attach all plastic clips on the seat unit to the walker body in the following order:

A. (See Fig 1) Starting with the seat unit's arm rests, insert clips through the holes (1) and (2) in the seat unit fabric then insert the clips into holes (A1) and (A2) on the walker body.

B. Next, attach the seat unit's backrest by pushing the plastic clips into holes (B1), (B2), (B3) and (B4). Start from one side and work your way around. Grip the back of the seat unit as low down as possible (Fig 2), feeling for the head of the clip and ensuring the clip is lined up with its hole, push the clip in (Fig 2a).

Note: If a clip is not protruding from the seat unit you may need to locate it and pull it through the hole in the seat cover.

C. Finally insert the pins at the front of the seat unit into keyhole slots (C1), (C2) and (C3). (Fig 3)

WARNING: Ensure all pins and clips are properly attached before placing your child in the seat.

To remove: Squeeze the ends of each clip (fig 4) and push the clips back out from the walker body. Finally push pins (Fig 3) up and out from the walker body.

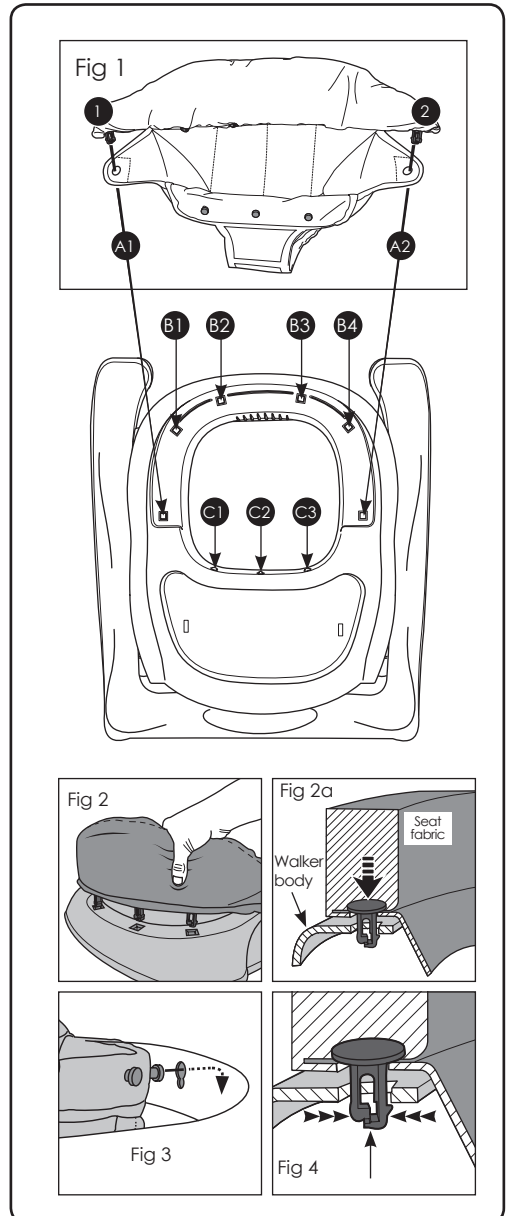

Attaching the Toys

1. Attach the toy bar bases (A) to the fixing points on the walker's recessed tray.

IMPORTANT: Ensure the slot on the underside of each toy bar base is positioned outermost.

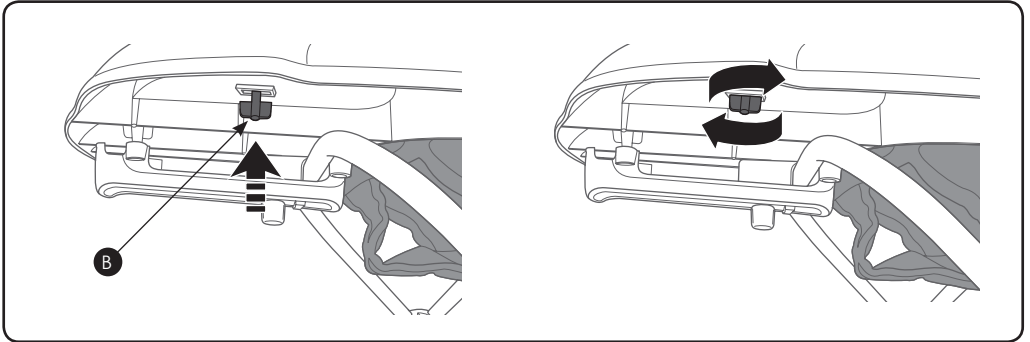
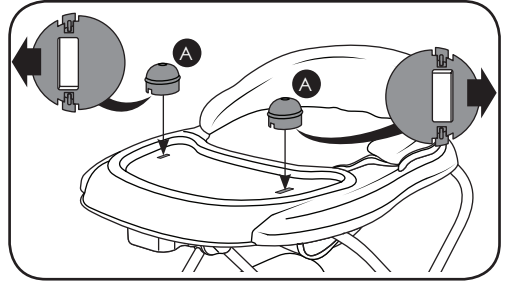

2. Secure the toy bar bases to the walker body by pushing the tabs (B) on the underside of the walker body, into the corresponding holes in the toy bar bases and then turning the tabs to fix in position. Reverse the above process to remove the toy bar bases.

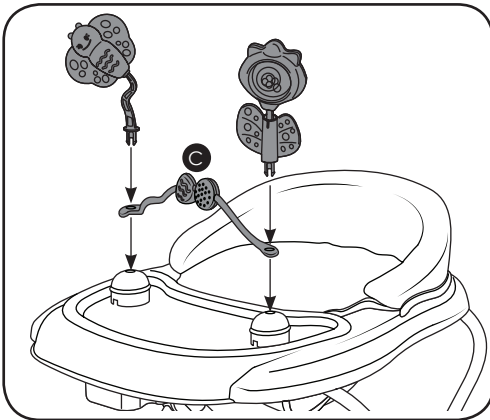

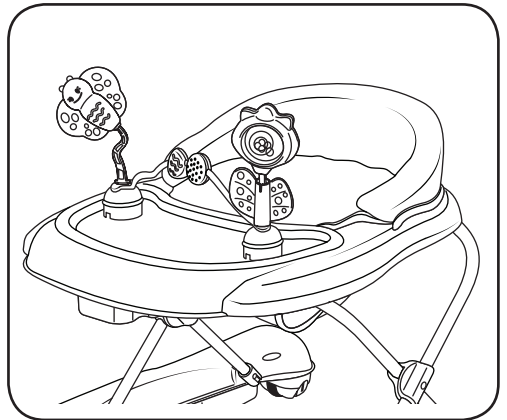

3. Attach the toy bar (C) to the toy bar bases by inserting the toy stems through the toy bar and into the toy bar bases.



4. Finally check the toys are firmly attached and the walker is ready to use.



If you have any questions or concerns regarding this product,
do not hesitate to contact our expert team online
via online4baby.com/contact-us

Feeling social?  
online4baby.com

Imported by Online4baby Ltd,
Meadowbank, Tweedale Way, Oldham, OL9 8EH