



**PUGGLE**

# **Fun 7 Inch Balance Bike**

**Instruction manual**

## *Welcome!*

Thank you for purchasing the Puggle Fun 7 Inch Balance Bike.

This instruction manual will guide you through the setup, use, and maintenance of your new balance bike, ensuring you get the most out of its versatile features. Please read through the following information and safety warnings carefully to fully understand and enjoy all the benefits your Balance Bike has to offer, and to ensure its safe operation.

### **We're here to help!**

If you have a query with this product or require replacement parts, please contact us at the web address below.

[thenurserystore.com/contact-us](https://thenurserystore.com/contact-us)

### **Follow us on social media:**

 Facebook

 Instagram

 YouTube

 TikTok

 X (formerly known as Twitter)

 Pinterest

## *Important Information*

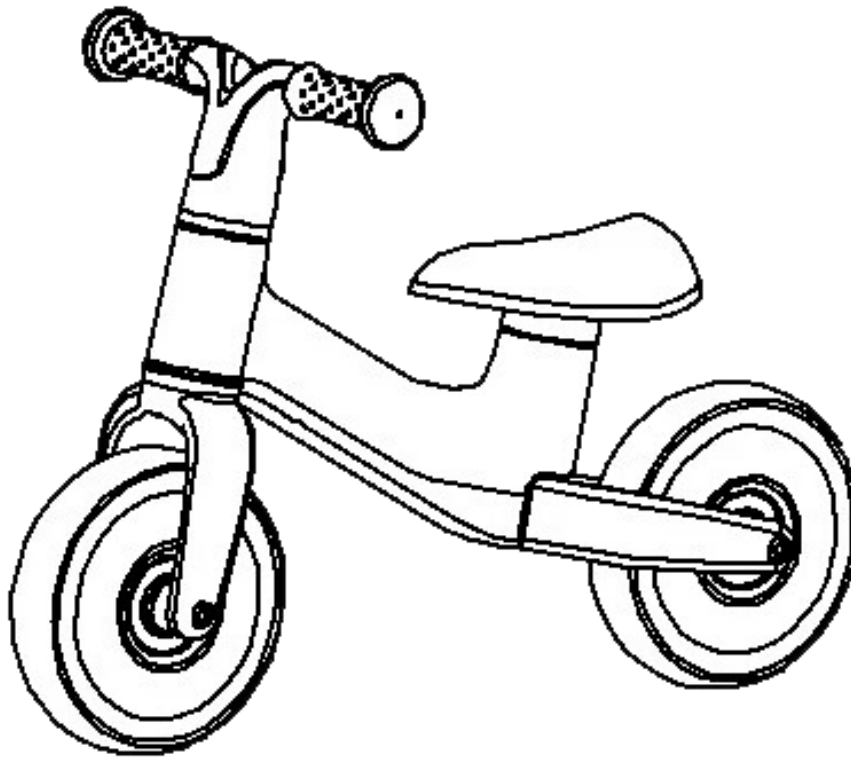

**IMPORTANT!** Your Balance Bike may differ slightly from images shown above and throughout, as the images used are for illustration purposes only.

Your Balance Bike is tested to comply with EN 71.

- Bags and other items should not be hung from the handles as this can affect the stability of the product.
- DO NOT use parts or accessories which are not approved or supplied by the manufacturer.
- DO NOT allow your child to play with this product without adult supervision.



## Safety Instructions

### **IMPORTANT – Read the instructions carefully before use and keep for future reference.**

- **WARNING:** A child's safety is your responsibility.
- **WARNING:** Adult assembly is required.
- **WARNING:** Ensure that all components are fitted securely into place and tightened where applicable before allowing your child to play with the balance bike.
- **WARNING:** Ensure that the child is supervised by an adult when using the balance bike at all times, and is taught about the correct usage of the product.
- **WARNING:** Ensure that all locking devices are engaged before usage.
- **WARNING:** This product is suitable for use by one child at a time only.
- **WARNING:** DO NOT overload this product, maximum capacity is 20kg.
- Approximate age range is 18 months to 4 years.
- **WARNING:** Keep hands and other limbs away from moving parts such as the wheel to prevent entrapment and injury.
- **WARNING:** Protective equipment should be worn. Children should wear approved protective equipment e.g. helmet and correct fitting is required.
- **WARNING:** DO NOT allow a child to ride on roadways, public highways or alleys. Not to be used in traffic.
- **WARNING:** DO NOT allow a child to ride on steeply sloped areas, near steps, swimming pools, or other bodies of water.
- For use on smooth, paved surfaces only.
- Ensure that the rider keeps both hands on the handlebar at all time for proper control.
- **WARNING:** DO NOT allow a child to ride the product at dusk, at night or at times of limited visibility.
- Children should be reminded that the toy should be used with caution, since it requires skill, so as to avoid falls or collision causing injury to the user and third parties. They should also be reminded of the dangers of using this product on public highways.
- All assembly fittings should always be tightened properly, checked periodically and the care should be taken that no bolts are loose, because a child could trap parts of the body or clothing (e.g. strings, necklaces, ribbons for babies' dummies), which could pose a risk of suffocation and strangulation.
- Replace broken or worn parts immediately, only use parts supplied or approved by the manufacturer.
- This Balance Bike conforms to BS EN 71. 

## *Symbols and their meaning*

There are a number of symbols used through this manual, please find below breakdown of what each symbol is and what it means.

	<p>European conformity – This mark is applied to both physical product and product packaging, indicating conformity with the relevant European testing standards.</p>
	<p>UK Conformity Assessed – This mark is applied to both physical product and product packaging, indicating conformity with the relevant UKSI testing standards.</p>
	<p>Direction indicator showing direction of assembly, rotation, function.</p>

## *What's in the box*

**x1 Puggle Fun 7 Inch Balance Bike**

**x1 Instruction Manual**

## *Before Assembly*

Before assembly, please ensure that you have read and understood the instructions. Then carefully unpack your balance bike and ensure that all parts are present, please see parts list as follows.

## Parts List

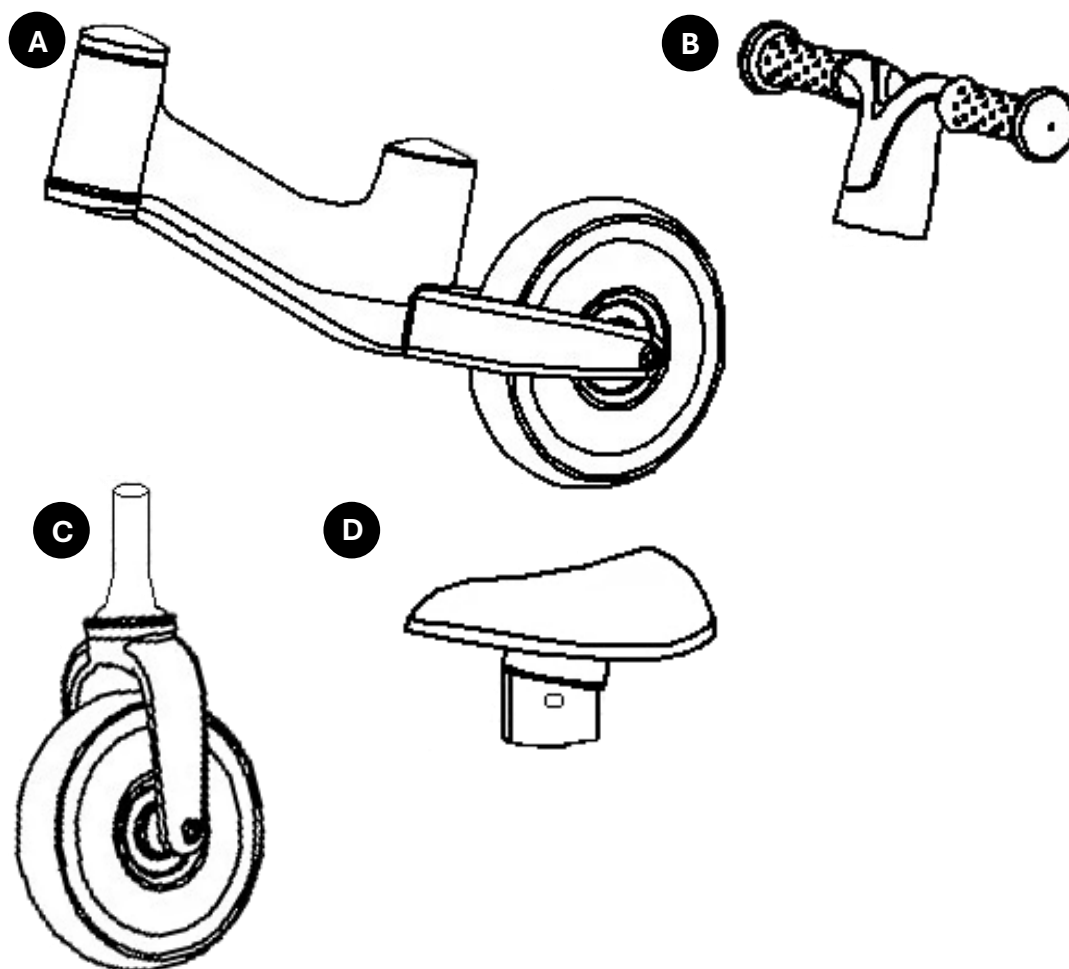

### Parts included with your Balance Bike are:

Part	Description	Quantity
A	Main Body	1
B	Handlebar	1
C	Front Wheel	1
D	Seat	1

Discard packaging in accordance with your local authority guidelines.

The balance bike should be assembled on a clean surface, free from any sharp objects that could mark or damage the product.

**CAUTION:** There are many small components used in the construction of this balance bike. These items should be kept out of reach of young children whilst assembling the unit.

## Assembling the Balance Bike

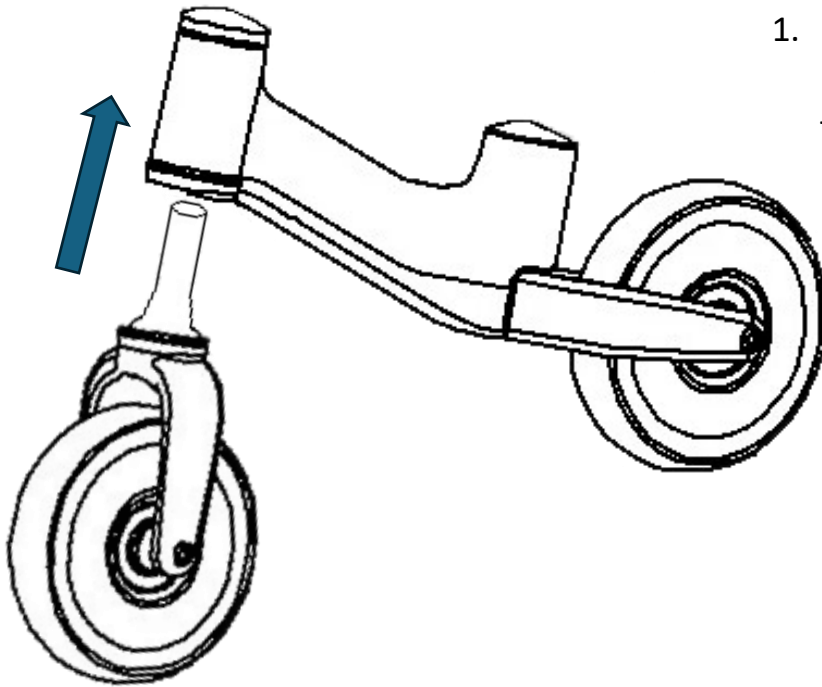

1. Insert the Front Wheel (C) into the Main Body (A) as shown in the diagram on the left.

2. Place the Handlebar (B) down onto the Main Body (A) and it should click into place on the shaft of the Front Wheel (C). Pull up on the Handlebar (B) to check securely in place.

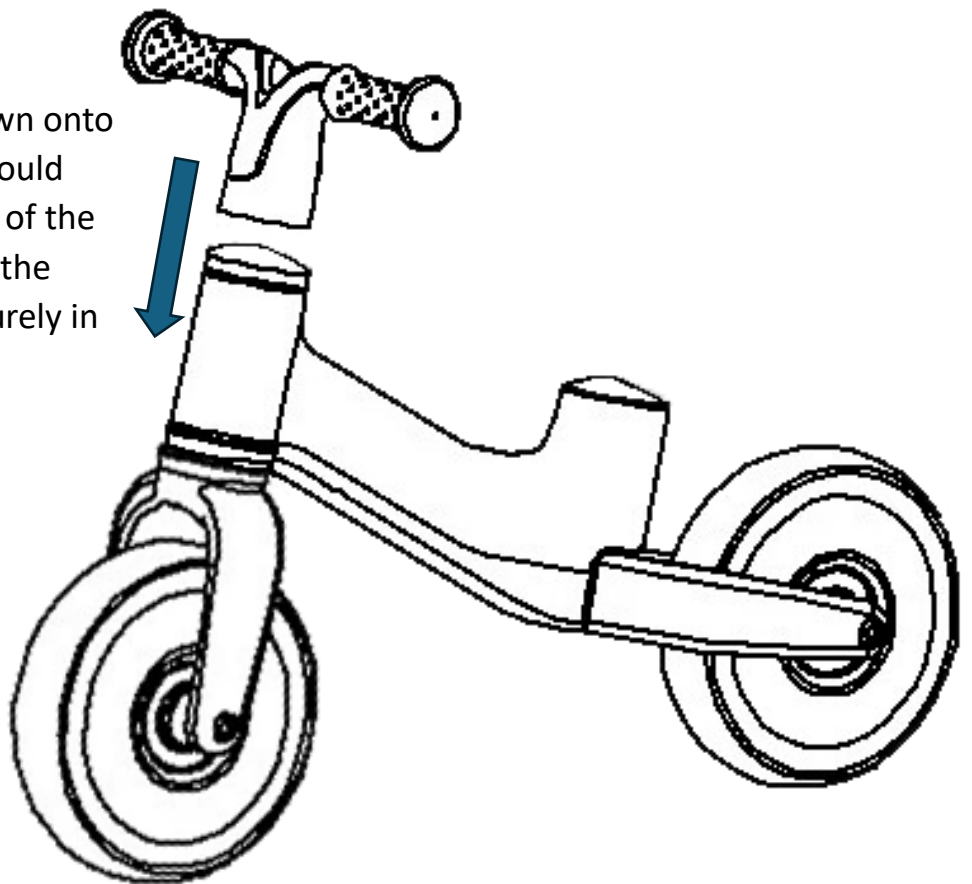

## Assembling the Balance Bike

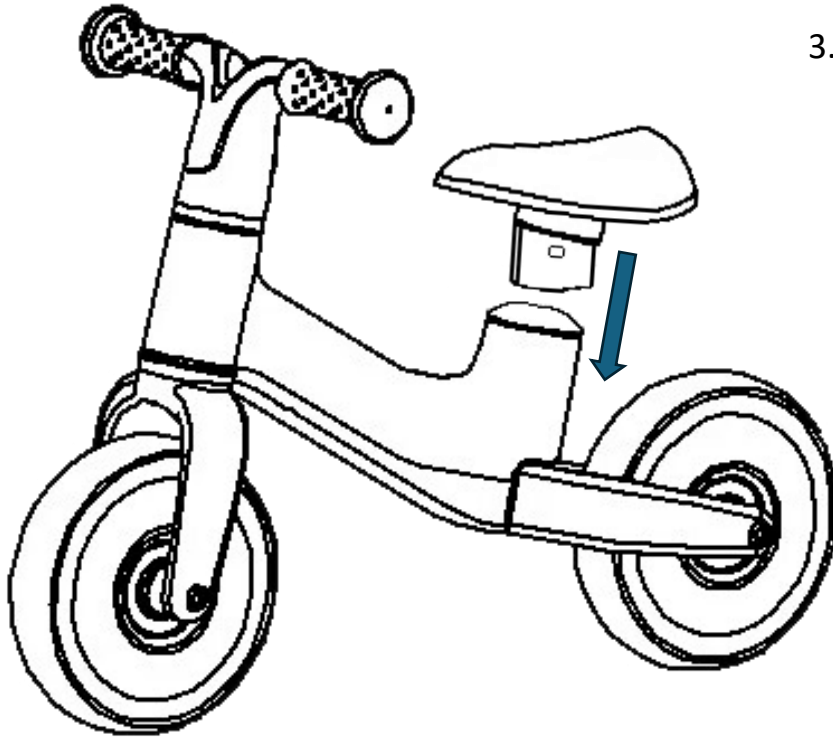

3. Insert the Seat (D) into the Main Body (A) as shown in the diagram on the left until it clicks into place. Pull up on the Seat (D) to check securely in place.

4. The Balance Bike is now fully assembled and ready to use.

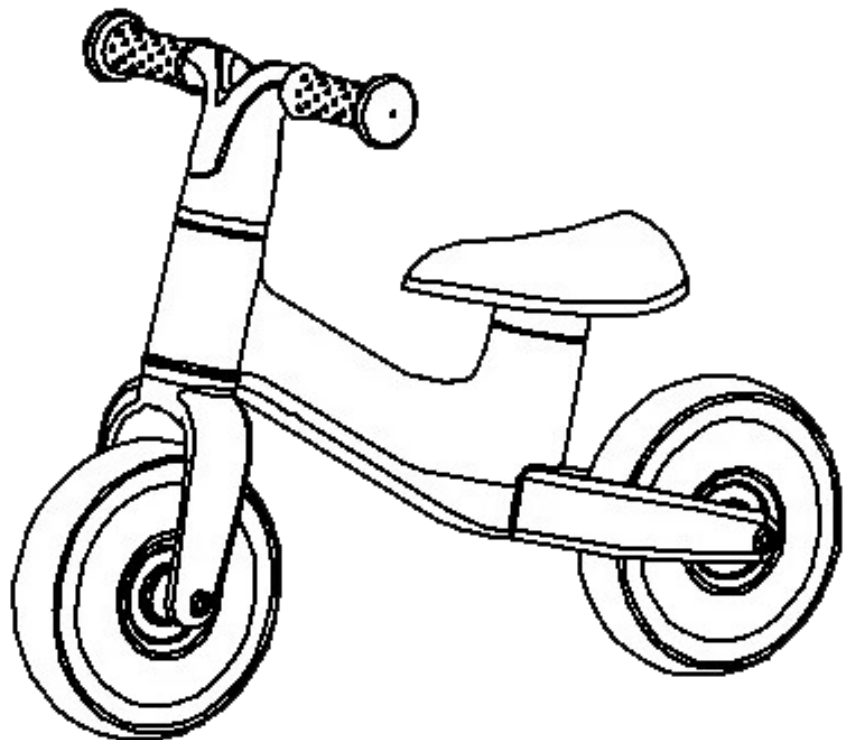



## *Care and Maintenance*

### *Cleaning*

- Scuff marks may be removed with a soft, damp cloth.
- DO NOT use harsh or abrasive cleaners or bleaches on this product, as they may damage the product.

### *Maintenance*

- Periodically check all fixings to ensure they remain tight and tighten where required.
- Regularly inspect the wheels, locks, harness, catches, seat adjusters, joints and fixings to ensure they are clean, operating correctly and in full working order.
- Do not use this product if any part is broken, torn or missing and use only spares provided by the manufacturer.
- If parts become stiff or difficult to operate, ensure dirt is not the cause, then try a light application of a silicon lubricant, ensuring it penetrates between the components. Regular lubrication of moving parts will extend the life of your product and make opening and folding easier.
- After exposure to damp conditions, dry off with a soft cloth and leave fully open in a warm environment. Storing damp will encourage mildew to form.
- Store in a dry place.
- Do not leave in sunlight for prolonged periods as some colours may fade.

## *Troubleshooting Tips*

Issue	Possible Root Cause	Solution
Joints are stiff, in particular elbow joint	Lack of lubricant	Lubricate joint as per the instructions in the maintenance section.
Parts do not click into place.	Parts are not correctly aligned.	Ensure that parts align correctly and click into place as per the assembly instructions.

For any and all other product issues not covered in the above please contact our dedicated customer services team at the below web address and they will endeavour to resolve any queries that you may have as soon as possible.

[thenurserystore.com/contact-us](https://thenurserystore.com/contact-us)

## *Recycling the packaging*

When you've unpacked your product and have ensured that all parts are present, please discard packaging components in accordance with your local authority guidelines, for further information please check the material and your postcode at <https://www.recyclenow.com/recycle-an-item>. Your packaging will include the following materials;

Carton – 5Ply Corrugated Paper – Widely recycled in your card and paper bin

Polybag – PE Plastic – Recycle with bags at large supermarkets

## WARRANTY

Thank you for purchasing your Puggle product.

At the nursery store we endeavour to provide quality, affordable products and as such we look to provide you as a proud parent with peace of mind that your Puggle product comes with a standard 12 months warranty

Your Puggle product is guaranteed for 12 months from the date of original purchase. If any defects should arise due to faulty workmanship or material, your faulty product should be returned to us and repair, replacement or refund will be at our discretion based upon thorough investigation from our QA team.

The guarantee is subject to the following provisions:

- The product must be assembled correctly and operated in accordance with the requirements contained within the instruction manual.
- The product must be solely used for domestic purposes.
- It does not cover general wear and tear, damage, misuse or any consumable parts.
- The warranty is rendered invalid if the product has been resold or has been damaged through inexpert repair.
- The warranty is only valid within the UK.

You do not need to validate your 12 month warranty, it will be effective as of initial purchase date.

For full terms and conditions please see online at,  
[www.thenurserystore.com/s/12-month-product-warranty-registration](http://www.thenurserystore.com/s/12-month-product-warranty-registration)

# PUGGLE

**[thenurserystore.com](http://thenurserystore.com)**

Imported by Online4baby Ltd.

Meadowbank, Tweedale Way, Oldham, OL9 8EH